

ILLUMINANCE METER T-10/T-10M

INSTRUCTION MANUAL

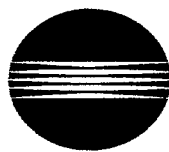



MINOLTA

Safety Symbols

The following symbols are used in this manual to prevent accidents which may occur as a result of incorrect use of the instrument.

 Denotes a sentence regarding a safety warning or note.
Read the sentence carefully to ensure safe and correct use.

 Denotes a prohibited operation.
The operation must never be performed.

 Denotes an instruction.
The instruction must be strictly adhered to.

 Denotes an instruction.
Disconnect the AC adapter from the AC outlet.

 Denotes a prohibited operation.
Never disassemble the instrument.

STATEMENT OF FCC COMPLIANCE

This device complies with Part 15 of the FCC Rules. Operation is subject to the following conditions: (1) This device may not cause harmful interference, and (2) this device must accept any interference received, including interference that may cause undesired operation. Changes or modifications not approved by the party responsible for compliance could void the user's authority to operate the equipment. This equipment has been tested and found to comply with the limits for a Class B digital device, pursuant to Part 15 of the FCC Rules. These limits are designed to provide reasonable protection against harmful interference in a residential installation. This equipment generates, uses and can radiate radio frequency energy and, if not installed and used in accordance with the instructions, may cause harmful interference to radio communications. However, there is no guarantee that interference will not occur in a particular installation. If this equipment does cause harmful interference to radio or television reception, which can be determined by turning the equipment off and on, the user is encouraged to try to correct the interference by one or more of the following measures:

Reorient or relocate the receiving antenna.

Increase the separation between the equipment and receiver.

Connect the equipment into an outlet on a circuit different from that to which the receiver is connected.

Consult the dealer or an experienced radio/TV technician for help.

This Class B digital apparatus complies with Canadian ICES-003.

Cet appareil numérique de la classe B est conforme à la norme NMB-003 du Canada.

CONTENTS

| | |
|--|----|
| SAFETY PRECAUTIONS | 1 |
| Names and Functions of Parts | 4 |
| ● Basic Operation ● | 7 |
| Preparation | 8 |
| Installing the Receptor Head | 8 |
| Removing the Receptor Head | 8 |
| Selecting measuring units | 8 |
| Attaching the Strap and Cap | 9 |
| Attaching the Cap (Without Strap) | 9 |
| Putting the Instrument in the Case | 10 |
| Installing the Batteries | 11 |
| Turning Power ON | 11 |
| Zero Adjustment | 12 |
| Selecting the Response Speed | 12 |
| Battery Alarm | 12 |
| Measuring the Illuminance | 13 |
| Measuring Method | 13 |
| Measuring the Illuminance Difference / Ratio | 14 |
| Entering the Reference Value | 14 |
| Measuring the Illuminance Difference / Ratio | 18 |
| Measuring the Integrated Illuminance | 19 |
| Automatic Integration Stop Function | 21 |
| Setting Method | 21 |
| Checking the Setting | 24 |
| Changing the Setting | 24 |
| Operating the Instrument with External Power | 25 |
| Connecting the AC Adapter | 25 |
| ● Advanced Operation ● | 27 |
| Color Correction Factor (C.C.F.) | 28 |
| Measurement using the CCF | 28 |
| CCF Setting Method | 29 |
| Setting the Range Manually | 32 |
| Setting Method | 32 |
| Over-range Error | 33 |
| Recording the Measured Illuminance Continuously (Analog Output) | 34 |
| Printing the Measured Data (Digital Output) | 36 |
| Printer Requirements | 36 |
| Procedure | 36 |
| Connecting to a Personal Computer (Digital Output) | 38 |
| Separating the Receptor Head from the Main Body | 39 |
| Items Required | 39 |
| Measuring Method | 39 |
| Fixing the Receptor Head | 40 |
| Multi-Point Measurement | 41 |
| Items Required | 41 |
| Measuring Method | 41 |
| Notes on Multi-Point Measurement | 44 |
| ● Introduction of Accessories ● | 45 |
| Standard Accessories | 46 |
| Optional Accessories | 47 |
| System Diagram | 48 |
| ● Explanation ● | 49 |
| Error Messages | 50 |
| Reference Measurement Plane / Dimension Diagram | 51 |
| Relative Spectral Response | 52 |
| Cosine Correction Characteristics | 53 |
| Specifications | 54 |

Names and Functions of Parts

T-10

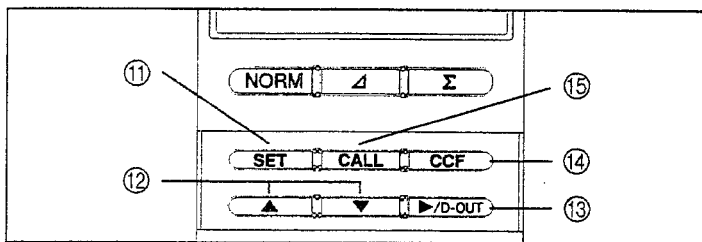
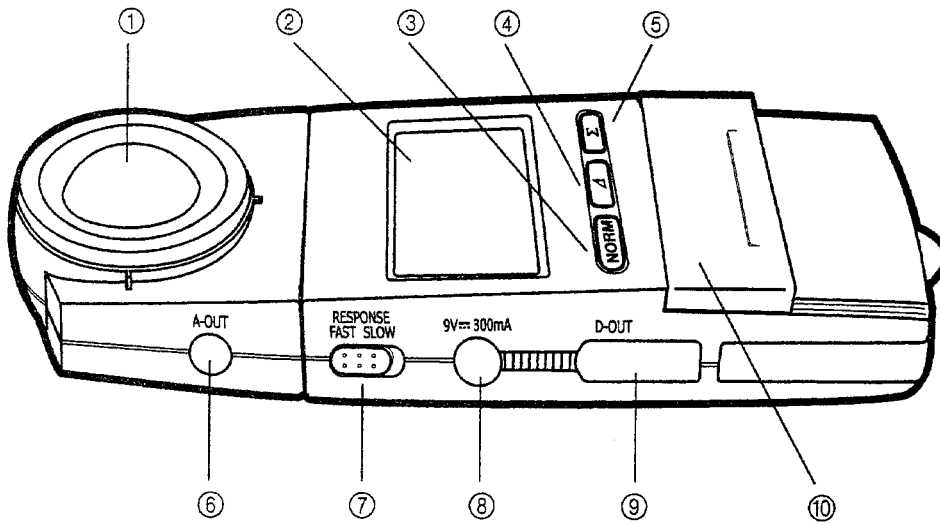

(▲ When the slide cover is open)

① Receptor window

② Display section

Mode selector keys

③ [NORM] key Switches to normal illuminance measurement mode.

④ [Δ] key Switches to illuminance difference/ratio measurement mode, and switches the displayed value between the illuminance difference and ratio.

⑤ [Σ] key Switches to integrated illuminance measurement mode and displays the measured integrated illuminance.

⑥ Analog output terminal Outputs an analog signal to a recorder etc.

⑦ Response speed selector switch Switches between FAST and SLOW.

⑧ AC adapter terminal Connect the optional AC adapter (AC-A10) to this terminal.

⑨ Digital output terminal Outputs measured data to a PC or a printer.

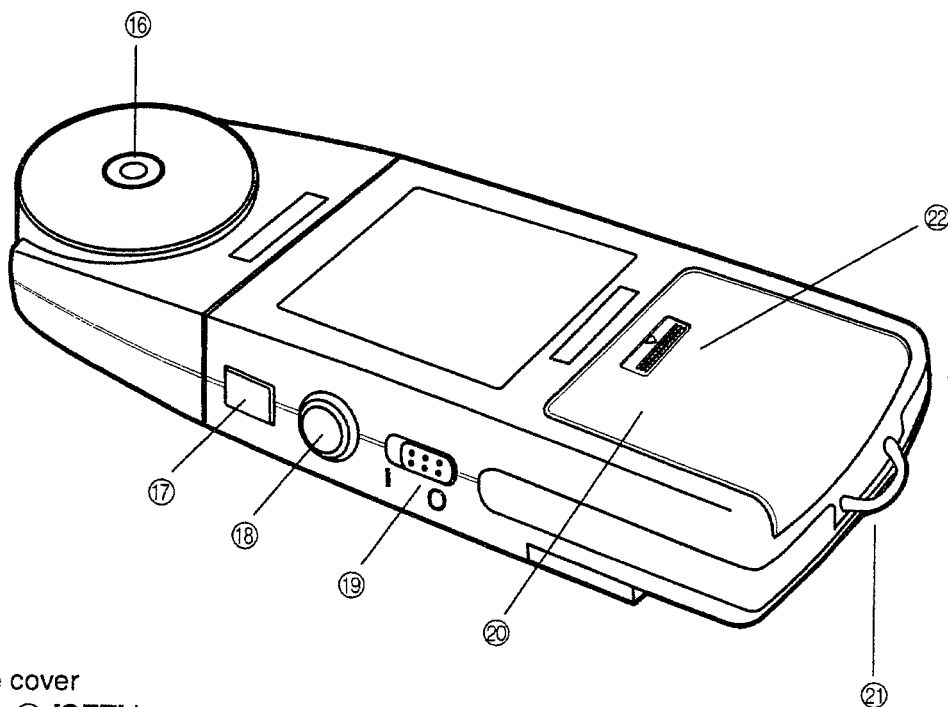

› Slide cover

- ⑪ [SET] key • Activates SET mode.
• Confirms the numeric setting.
- ⑫ [▲][▼] keys Changes the currently set value and decimal point position.
- ⑬ [▶/D-OUT] key In normal mode, this key is used to output data to a personal computer or printer. In SET mode, this key is used to shift from one digit to another when changing the currently set value using the [up] and [down] keys.
- ⑭ [CCF] key Sets the color correction factor.
- ⑮ [CALL] key Calls the currently set data.

› Tripod fixing screw hole

› Receptor head remove button Press this button to detach the receptor head from the main body.

› Hold button

RUN state The button is pushed out. Measurement is performed repeatedly.

HOLD state The button is pushed in. Measurement is paused and the measured value in effect just before measurement was paused is held. Pushing this button and releasing it again will place the instrument in RUN state.

› Power switch

› Battery cover

› Strap hook

› Measuring-unit selector Allows selection of lx or fcd.
(Inside the battery chamber, refer to page 8) (Screen examples given in this manual are mainly for lx.)

T-10M

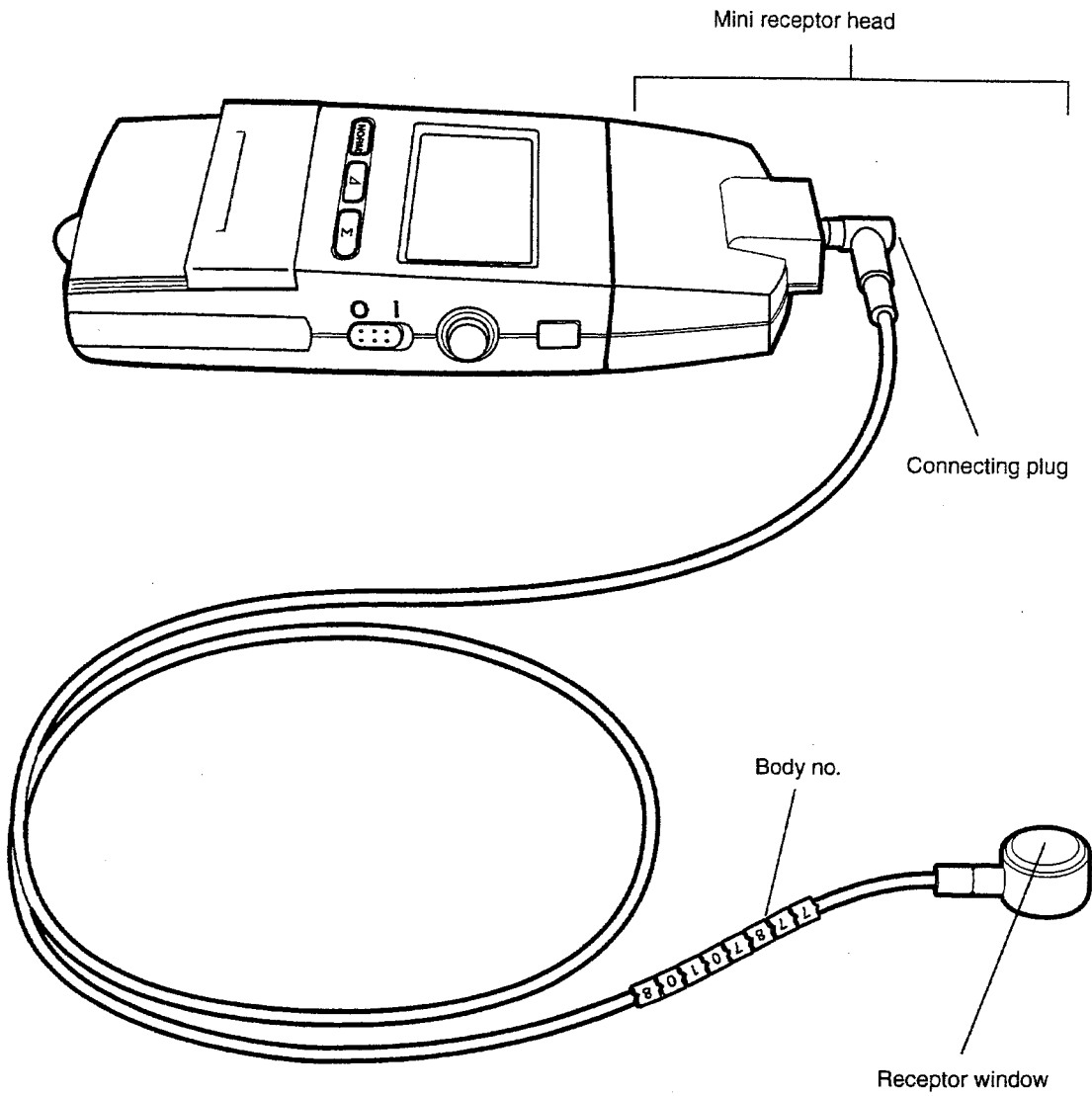

Notes on T-10M Body No.

A body no. is indicated in two places as shown below: one on the sensor (receptor head code) and the other on the back of the adapter (main body side).

When using two or more T-10M (mini receptor head) units, make sure that the body no. on each sensor matches the one on the corresponding adapter.

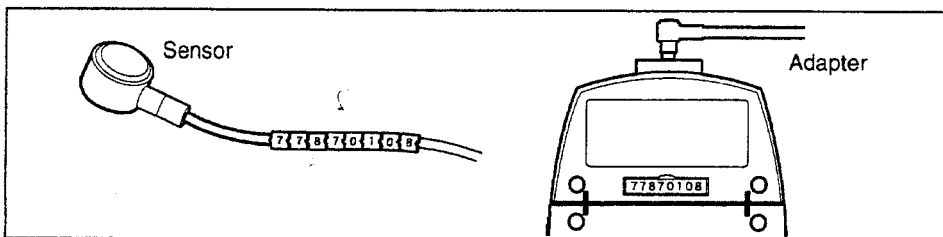

Basic Operation

Attaching the Strap and Cap

When attaching the strap to the main body, attach the cap to the strap as shown below.

1. Pass the strap through the string extended from the cap, then attach the strap to the main body.

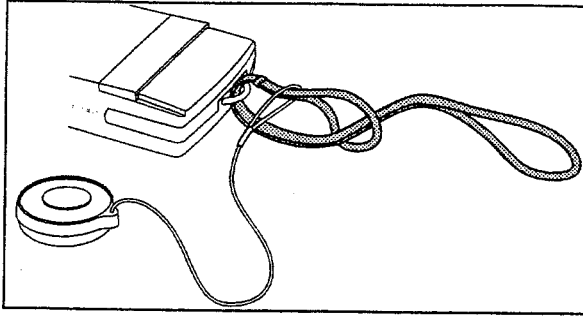

Attaching the Cap (Without Strap)

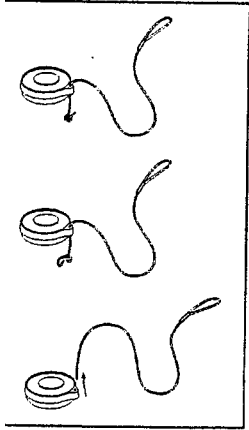

1. Untie the strap attached to the cap, and remove the strap from the cap.

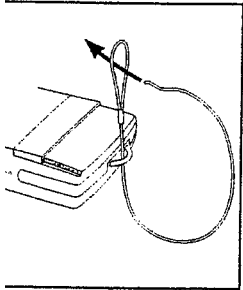

2. Attach the strap to the strap hook as shown.

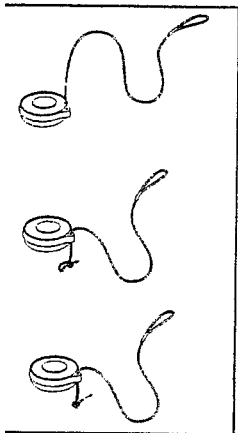

3. Pass the strap through the cap, and knot the end of the strap so that it does not become detached from the cap.

Putting the Instrument in the Case

■ For T-10

Attach the cap to the receptor window and put the instrument into the case.

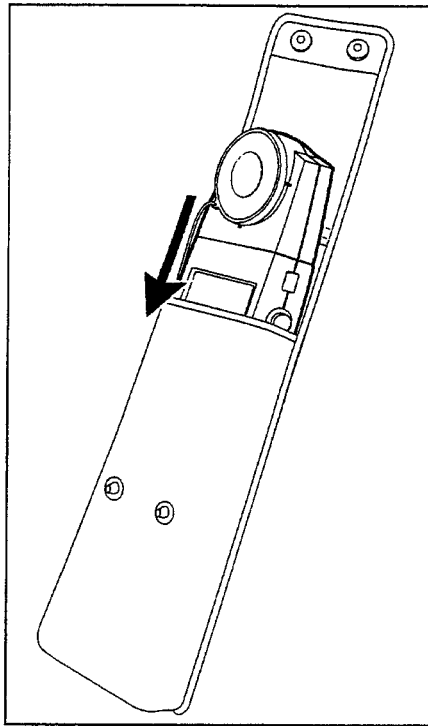

■ For T-10M

Remove the sensor plug from the mini receptor head, put the instrument into the case, then put the sensor into the pocket of the case.

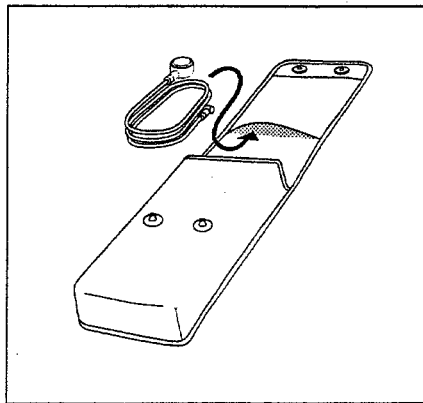
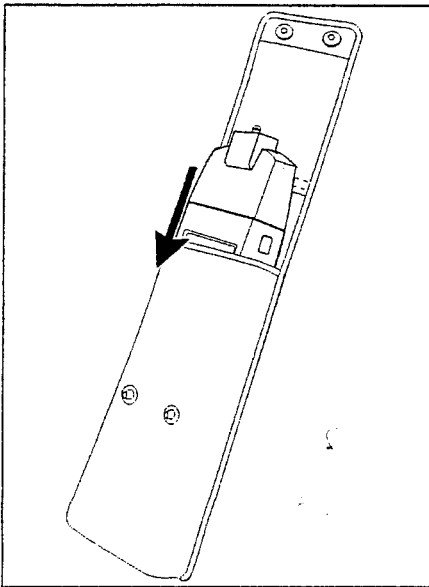

Installing the Batteries

⚠ WARNING

- ⊘ Do not put the batteries on a fire, charge them (if they are not chargeable), short-circuit them, heat them or disassemble them. Doing so may cause an explosion or heat generation, resulting in fire or injury.

⚠ CAUTION

- ⊘ Do not use batteries other than those specified by MINOLTA. When installing batteries in the instrument, make sure that they are correctly oriented according to the (+) and (-) marks. Also make sure not to mix new and old batteries, or mix batteries of different types. Failure to adhere to these instructions may cause batteries to explode or leakage of electrolyte, resulting in fire, injury or air pollution.

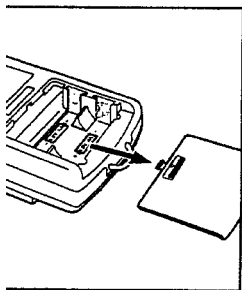

1. Set the power switch to "O" (OFF), and pull the battery cover as shown while pressing it down slightly.

- Have two AA-size batteries ready.

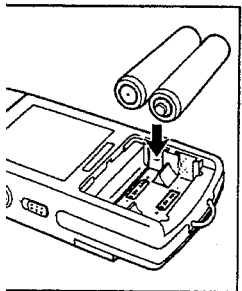

2. Install the batteries in the correct direction, then put the cover on.

Turning Power ON

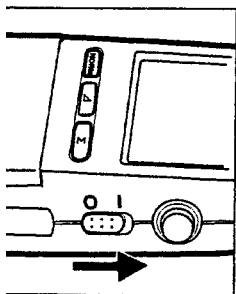

1. Set the power switch to "I" (ON).

- Setting the power switch to "I" (ON) with the hold button pushed out (RUN) will start measurement immediately.
- Setting the power switch to "I" (ON) with the hold button pushed in (HOLD) will not start measurement. To start measurement, the hold button needs to be pushed out (RUN).

Zero Adjustment

Zero adjustment is performed automatically when the power switch is set to "1" (ON).

- "CAL" (calibration) will be displayed in the display section during zero adjustment.
- Zero adjustment is performed electrically, so no cap is required.
- When zero adjustment is complete, "CAL" will disappear and "0 lx (0.0 fcd)" will appear (if the hold button is pushed in (HOLD)).

Selecting the Response Speed

Set the response speed selector switch to FAST or SLOW according to the light source to be measured.

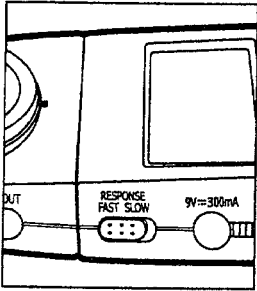

FAST:

To measure a normal light source such as daylight, lamplight and fluorescent light.

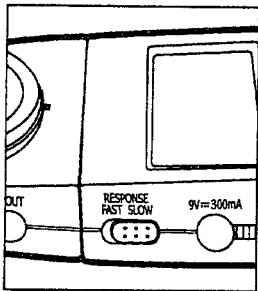

SLOW:

To measure average illuminance of a flicker light such as a movie projector, video projector and TV screen.

Battery Alarm

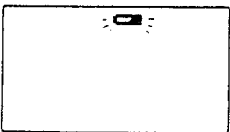

When the batteries are near depletion, a battery mark will appear above the measured value. If you still continue to use the instrument, the mark will start to blink and measurement will no longer be possible. In this case, replace the batteries with fresh ones.

- Use of fresh alkaline batteries enables continuous measurement for approximately 72 hours or more at normal temperatures.

Measuring the Illuminance

- When performing measurement, take care not to allow the shadow or reflection of the operator to enter the receptor window.

Measuring Method

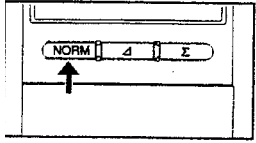

1. Press the [NORM] key.

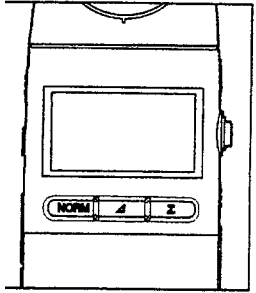

2. Push out the hold button (RUN).

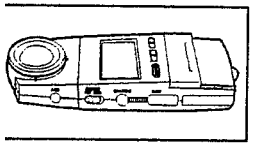

3. Place the receptor head in the desired measuring position.

- The spherical summit of the receptor window is used as the reference plane for measurement (see page 28).
- ◆ The illuminance at the measuring position will appear in the display section.
- To hold the measured value, push in the hold button. (The back-light in the displayed section will light up for 10 seconds if the measured value is 10 lx or less.)
- To cancel the hold, push the hold button again and release it.

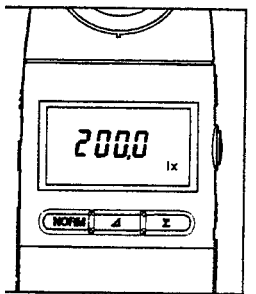

Measuring the Illuminance Difference / Ratio

This section explains how to measure the difference between the measured illuminance and reference illuminance as well as the ratio of the measured illuminance to the reference illuminance.

Entering the Reference Value

The reference value can be set in the following two ways.

- ① By setting the measured value as the reference value
- ② By entering the desired reference value numerically

① Setting the measured value as the reference value

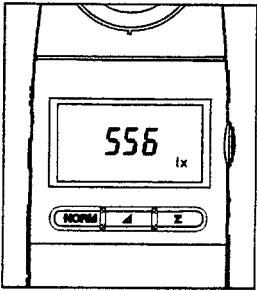

1. Operate the instrument as described in "Measuring the Illuminance" (page 11) and display the measured value. If the measured value is satisfactory as the reference value, hold it.

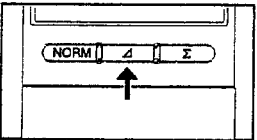

2. Press the [Δ] key.

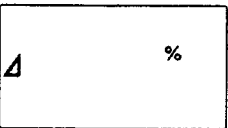

- ◆ "Δ lx" or "Δ %" will appear in the display section.
- Each time the [Δ] key is pressed, "Δ lx" or "Δ %" will appear alternately.

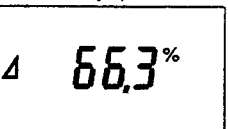
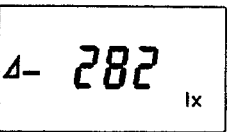

- If the reference value had already been set, the difference from the reference value (Δ lx) or the ratio to the reference value (Δ %) will appear.

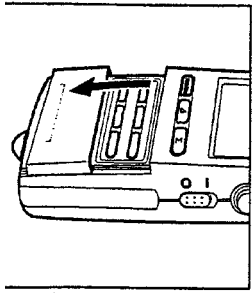

3. Open the slide cover and press the [SET] key.

- ◆ The reference value which has been held will blink.
- To cancel the reference value, press the [CALL] key.



4. Press the [SET] key again.

- ◆ The reference value will be set, and "±0 lx" or "100.0 %" will appear.



▶ To check the reference value, press the [CALL] key. The reference value will be displayed while the [CALL] key is held down.

2) Entering the desired reference value numerically

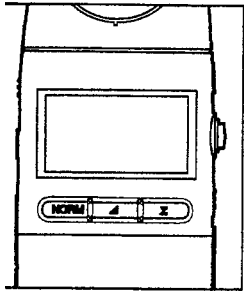

1. Operate the instrument as described in "Measuring the illuminance" (page 13). Make sure that the hold button is pushed out (RUN).

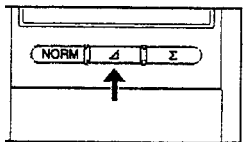

2. Press the [Δ] key.

- ◆ The mode will switch to illuminance difference/ratio measurement mode.

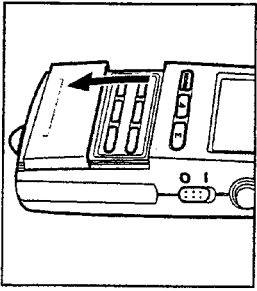

3. Open the slide cover and press the [SET] key.

- ◆ The instrument is now ready for you to enter a value, and one of the following values will appear.



- If no reference value had been set, "00.00" will appear (with the decimal point blinking).



- If the reference value had already been set, it will appear (with the decimal point, "0" or "00" blinking).



- If an integer value (i.e. a value which does not have a decimal point) has been set as the reference value, the three decimal points will blink.

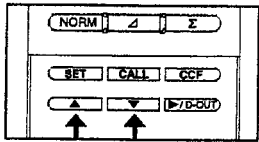

4. Select the effective digits of the reference value using the [▲] and [▼] keys.

- The display will change as follows each time the key is pressed.

(For Ix)

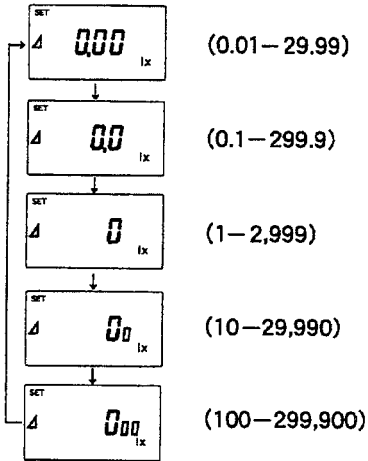

(For fcd)

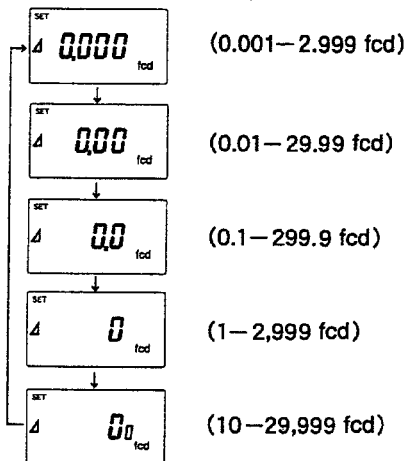

* In the above example, the [▲] key is pressed to change the display. The display will change in opposite direction if the [▼] key is pressed.

* Values in () indicate the settable range.

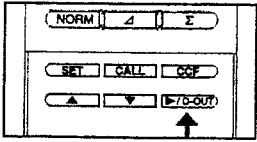

5. Press the [D-OUT] key to select the digit to be changed. The value at the selected digit will blink.



6. Change the value using the [▲] and [▼] keys.

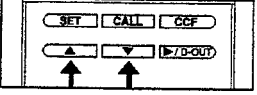

7. Repeat steps 5 and 6 to complete entry of the desired reference value.



- To cancel entry of the reference value, press the [CALL] key.

8. If the entered reference value is satisfactory, press the [SET] key.

- ◆ The reference value will be set, and "±0 lx" or "100.0 %" will appear.

- To check the entered reference value, press the [CALL] key. The reference value will be displayed while the [CALL] key is held down.

Measuring the Illuminance Difference / Ratio

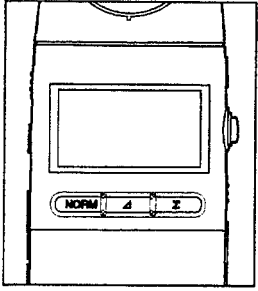

1. Push out the hold button to switch from HOLD to RUN.

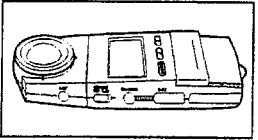

2. Place the receptor head in the desired measuring position.

- ◆ The measured illuminance difference or ratio will appear.
- Each time the [Δ] key is pressed, the illuminance difference or ratio will appear alternately.

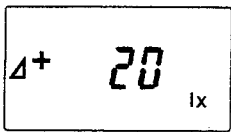

- Example)
- ← 20 lx brighter than the reference value



← 30 lx darker than the reference value

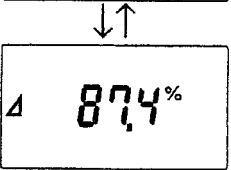

- The measured illuminance is displayed in a percentage (%), with the reference value set as 100.
- ← 87.4% of the reference value

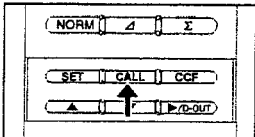

- To check the currently set reference value, press the [CALL] key. The reference value will be displayed while the [CALL] key is held down.

- Once the reference value is set, it will remain effective until it is changed.
- To delete the reference value, carry out the steps described in ②, "Entering the desired reference value numerically" and then enter "0".
- The display range of illuminance difference is from "- reference value" to "maximum display value within the measuring range - reference value".
- The display range of illuminance ratio is from 0.0% to 999.9%. "----" will blink if the illuminance ratio exceeds this range.

Measuring the Integrated Illuminance

This instrument enables you to measure integrated illuminance (lx·h), integration time (h) and average illuminance (lx).

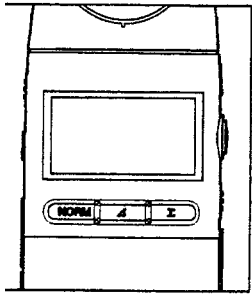

1. Set the power switch to "O" (OFF) and push in the hold button (HOLD).

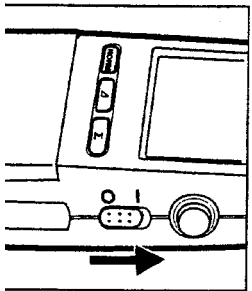

2. Set the power switch to "I" (ON).

- "0 lx" will appear in the display section.

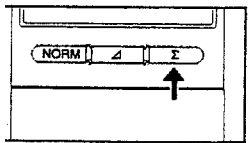

3. Press the [Σ] key to switch the mode and make sure that "0.00 lx·h (0.000 fcd·h)" is displayed (or "0.000 h" in the case of integration time display mode).

4. Place the receptor head in the desired measuring position.

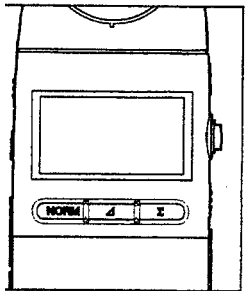

5. Push out the hold button (RUN).

- ◆ Measurement (integration) will start immediately after the hold is canceled (i.e. the hold button is pushed out).
- Each time the [Σ] key is pressed, the display mode switches from one to another.

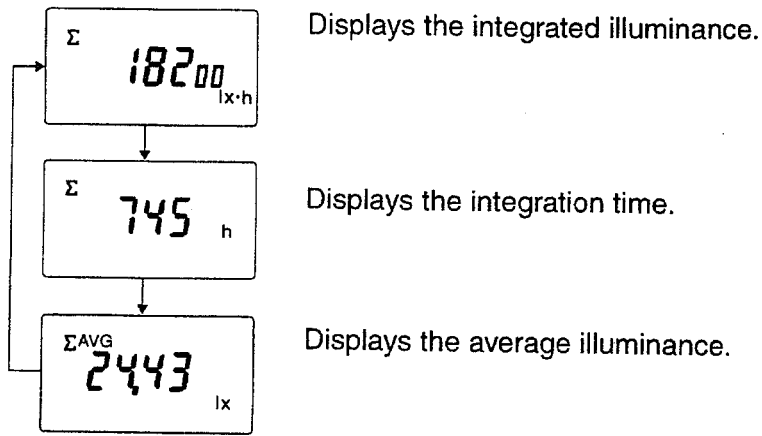

- Integration can be continued even if measurement of illuminance or illuminance difference/ratio is in progress. However, if the hold button is pushed in (HOLD), integration will be paused.
- To reset integration, set the power switch to "O" (OFF).
- The maximum measurable value and minimum unit for each display mode are given in the table below.

| | Minimum unit | Maximum value |
|------------------------|--|--|
| Integrated illuminance | 0.01 lx·h (= 36 lx sec) 0.001 fcd·h (= 3.6 fcd·sec) | 999,900 x 10 ³ lx·h 99,990 x 10 ³ fcd·h |
| Integration time | 0.001 h (= 3.6 sec) | 9,999 h |

Automatic Integration Stop Function

The instrument has a function that stops measurement automatically when the preset integration time or integrated illuminance is reached during measurement of integrated illuminance.

- It is not possible to preset both integration time and integrated illuminance at the same time. The integration time or integrated illuminance, whichever is set last, will be effective.

Setting Method

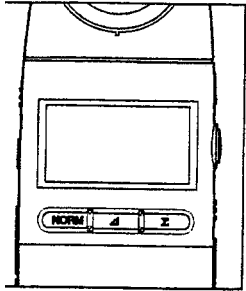

- Set the power switch to "O" (OFF) and push in the hold button (HOLD).

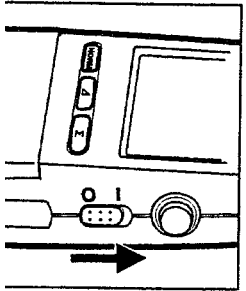

- Set the power switch to "I" (ON).
 - "0 lx" will appear in the display section.

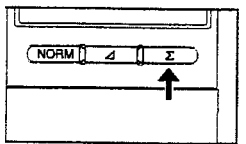

- Press the [Σ] key to switch the mode and make sure that "0.00 lx·h" is displayed (or "0.000 h" in the case of integration time display mode).

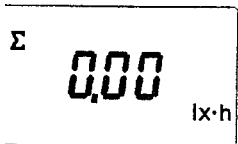

Displays the integrated illuminance.



Displays the integration time.

- The measurement unit will switch as shown below.

| | |
|---------------------|--------------------------|
| $\Sigma lx \cdot h$ | } → Integration time (h) |
| Σh | |
| $\Sigma AVG lx$ | |

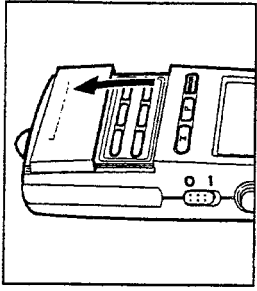

4. Open the slide cover and press the [SET] key.

- ◆ The instrument is now ready for you to enter a value, and "00.00" will appear (with the decimal point blinking).
- If the value (integration time or integrated illuminance had already been set, it will appear (with the decimal point "0" or "00" blinking).



- If an integer value (i.e. a value which does not have a decimal point) has been set as the reference value, the three decimal points will blink.

5. Select the effective digits of the value using the [▲] and [▼] keys.

- The display will change as follows each time the key is pressed.

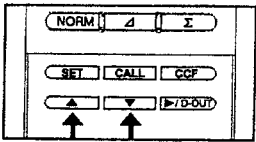

▼ Integrated illuminance

(For lx·h)

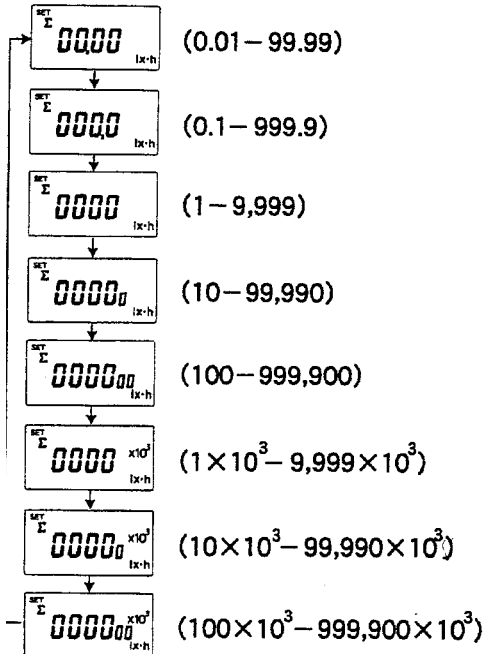

(For fcd·h)

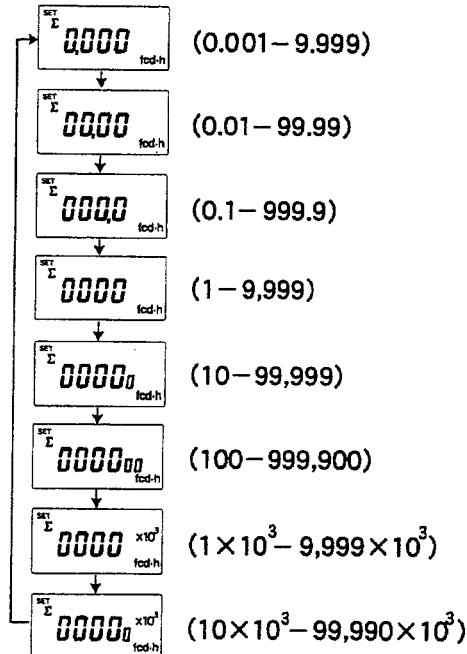

Integration time

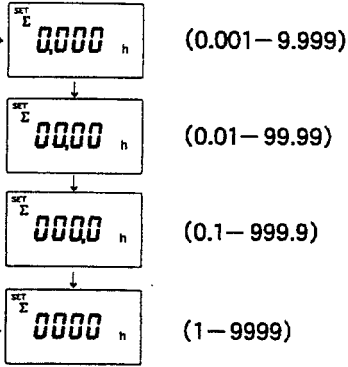

In the above example, the [▲] key is pressed to change the display. The display will change in opposite direction if the [▼] key is pressed.

Values in () indicate the settable range.

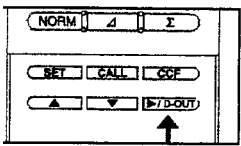

6. Press the [▶/D-OUT] key to select the digit to be changed. The value at the selected digit will blink.

7. Change the value using the [▲] and [▼] keys.

8. Repeat steps 6 and 7 to complete entry of the desired value.

- To cancel entry of the value, press the [CALL] key.

9. If the entered value is satisfactory, press the [SET] key.

- ◆ The value will be set.

10. Push out the hold button (RUN).

- ◆ Measurement (integration) will start immediately after the hold is canceled (i.e. the hold button is pushed out).
- ◆ When the preset integration time or integrated illuminance is reached, measurement will stop automatically.

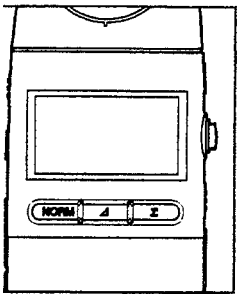

11. The unit will blink, indicating that measurement is currently paused.

- This also occurs in normal and Δ modes.

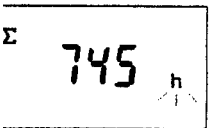

12. Set the power switch to "O" (OFF).

- If the power switch is not set to "O" (OFF) to reset the instrument, it will also be impossible to perform measurement in other modes.

Checking the Setting

- To check the currently set value, press the [CALL] key. The currently set value will be displayed while the [CALL] key is held down.

Changing the Setting

If you want to change the currently set value while measurement is in progress, carry out steps 4 to 9.

- The value you are going to set must be larger than the currently set value. If a value smaller than the currently set value is set, "Err A" will appear, causing the SET mode to be exited.

Operating the Instrument with External Power

⚠ WARNING

- ❗ Always use the AC adapter supplied as an optional accessory, and connect it to an AC outlet of the rated voltage and frequency. Using a non-specified AC adapter or connecting it to an incorrect AC outlet may damage the instrument or AC adapter, causing a fire or electric shock.
- If the instrument will not be used for a long time, disconnect the AC adapter from the AC outlet. Accumulated dirt or water on the prongs of the AC power cord's plug may cause a fire and should be removed.
- ⚡ When disconnecting the AC power cord's plug, always hold the plug and pull it to remove it. Never pull the AC power cord itself. Doing so may damage the AC power cord, causing a fire or electric shock.
- ⊘ Do not insert or disconnect the AC power cord's plug with wet hands. Doing so may cause electric shock.
- ❗ The instrument should not be operated if it is damaged or AC adapter is damaged, or if smoke or odd smells occur. Doing so may result in a fire. In such situations, turn the power OFF immediately, remove the batteries (or disconnect the AC adapter from the AC outlet), and contact the nearest Minolta-authorized service facility.

The rated voltage/ampere for the AC adapter terminal is 9Vdc/300mA. The terminal has two polarities: + (outer) and - (inner).

Never use any AC adapter other than MINOLTA's optional AC adapter (AC-A10 worldwide except N. America; AC-A10N in N. America).

Connecting the AC Adapter

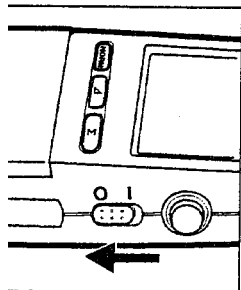

1. Set the power switch to "O" (OFF).

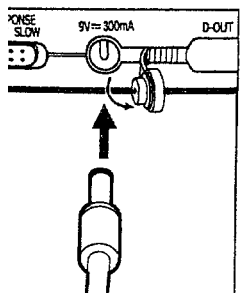

2. Connect the AC adapter to the AC adapter terminal.

3. Insert the AC adapter's cord plug to an AC outlet.

When unplugging the AC adapter, always set the power switch to "O" (OFF) first.

Advanced Operation

Color Correction Factor (C.C.F.)

When measuring under a light source which has a considerably different spectral distribution from MINOLTA's calibration light source, the instrument will cause an indication error due to slight deviation of the relative spectral response from spectral luminous efficiency ($V\lambda$). To correct this error, this instrument has CCF function (mode), allowing you to set the color correction factor (CCF).

In addition to the purpose of color correction, the CCF function can also be used for correction of indication errors between multiple T-10 illuminance meters and for user calibration under an accurately set light source.

Measurement using the CCF

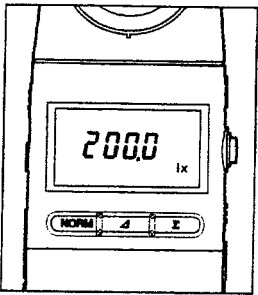

1. Push out the hold button (RUN).

◆ Measurement will start.

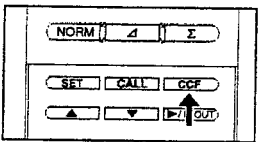

2. Open the slide cover and press the [CCF] key.

● In CCF mode, the following value is displayed.

Displayed value = Measured value x Color correction factor (CCF)

Pressing the [CCF] key will cancel correction, and the measured value which has not been corrected will be displayed.

Example) When CCF = 0.900:

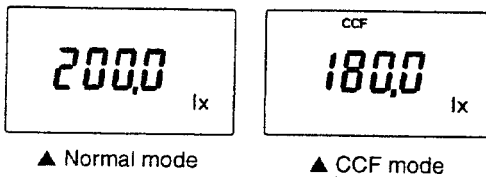

● Once the CCF is set, it will remain effective until it is changed.

CCF Setting Method

The CCF can be set in the following two ways.

Once the CCF is set, it will remain effective even if the power is turned OFF or the batteries are changed.

Entering the CCF directly

This method can be used if the CCF is known.

Entering the CCF

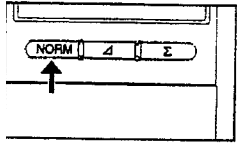

1. Press the [NORM] key to activate normal mode.

- The CCF can be set in normal mode only.

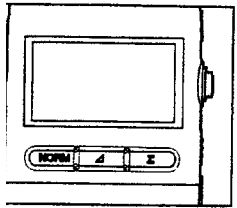

2. Push out the hold button (RUN).

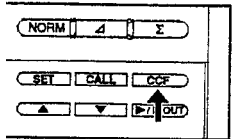

3. Open the slide cover and press the [CCF] key,

- ◆ CCF mode will be activated.

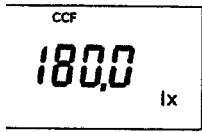

4. Press the [SET] key.

- ◆ The instrument is now ready for you to enter a value, and the currently set CCF (default: 1.000) will blink.

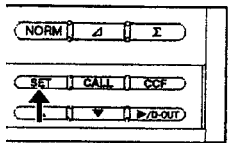

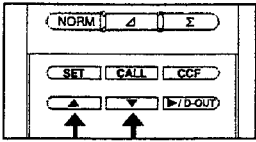

5. Change the CCF using the [▲] and [▼] keys.

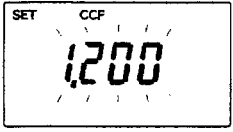

- ◆ Each time the [▲] or [▼] key is pressed, the value will change in 0.001 steps (settable range: 0.500 to 2.000). Holding the [▲] or [▼] key will cause the displayed value to change continuously.

- To exit setting, press the [CALL] key.

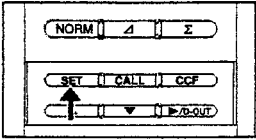

6. When you have changed the value, press the [SET] key.

- ◆ The CCF will be set.

- To check the currently set CCF, press the [CALL] key. The currently set CCF will be displayed while the [CALL] key is held down.

② Entering the reference value

If you have a strictly controlled reference light source, the correction factor (CCF) can be obtained using the CCF function.

If the reference illuminance value of the target light source is known, just enter the reference value to the instrument. The CCF will be calculated and set automatically.

■ Entering the Reference Value

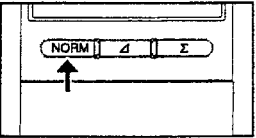

1. Press the [NORM] key to activate normal mode.

- The reference value can be set in normal mode only.

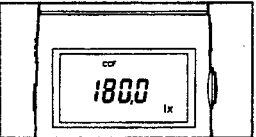

2. Push in the hold button (HOLD).

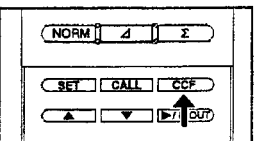

3. Open the slide cover and press the [CCF] key.

- ◆ CCF mode will be activated.

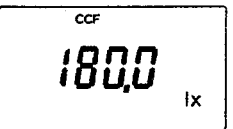

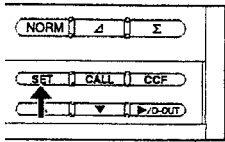

4. Press the **[SET]** key.

- ◆ The instrument is now ready for you to enter a value, and the currently displayed measured value will blink.

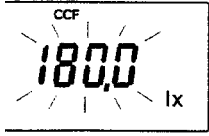

5. Enter the value using the **[▲]** and **[▼]** keys.

- ◆ Each time the **[▲]** or **[▼]** key is pressed, the value will change in steps of the smallest digit. Holding the **[▲]** or **[▼]** key will cause the displayed value to change continuously.

- To exit setting, press the **[CALL]** key.

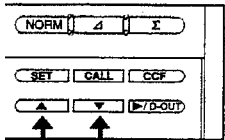

6. When you have entered the value, press the **[SET]** key.

- ◆ The CCF will be calculated from the entered reference value and then set.
- If the calculated CCF is out of the range of 0.500 to 2.000, "Err A" will appear, causing the SET mode to be exited.

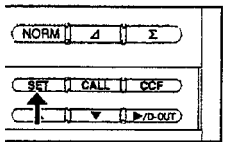

To check the currently set value, press the **[CALL]** key. The currently set value will be displayed while the **[CALL]** key is held down.

Setting the Range Manually

The measuring range is switched automatically from one to another during measurement ranges are available).

When you want to fix the range or you want to perform measurement of illuminance continuously using the analog output function (see page 28), set the measuring range as follows

Manual/auto measuring ranges

| Range | Measuring range (unit: lx) | | Measuring range (unit: fcd) | |
|-------|--------------------------------------|--|------------------------------------|--------------------------------------|
| | Manual | Auto | Manual | Auto |
| 1 | 0.00 – 29.99 | 0.00 – 29.99 | 0.000 – 2.999 | 0.000 – 2.999 |
| 2 | 0.0 – 299.9 | 25.0 – 299.9 | 0.00 – 29.99 | 2.50 – 29.99 |
| 3 | 0 – 2999 | 250 – 2999 | 0.0 – 299.9 | 25.0 – 299.9 |
| 4 | 0 ₀ – 2999 ₀ | 250 ₀ – 2999 ₀ | 0 – 2999 | 250 – 2999 |
| 5 | 0 ₀₀ – 2999 ₀₀ | 250 ₀₀ – 2999 ₀₀ | 0 ₀ – 2999 ₀ | 250 ₀ – 2999 ₀ |

- * The above measuring ranges are effective only when CCF correction is not used.
- * It is possible to find the currently selected range by the position of the displayed decimal point, "0" or "00".

Setting Method

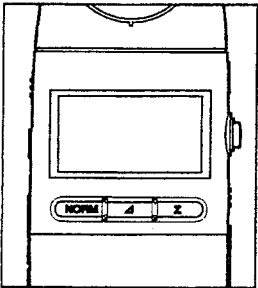

1. Have the instrument ready for operation as described in "Measuring the illuminance" (page 13) and push out the hold button (RUI

- The range can be switched in RUN state only.

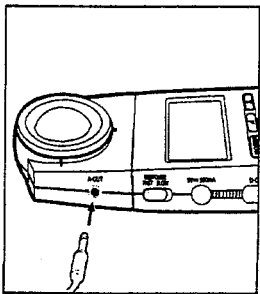

2. Insert the analog output mini plug into the analog output terminal

- ◆ "MANU." will appear in the display section.

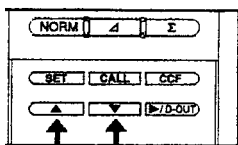

3. Open the slide cover and select the desired range using the [▲] and [▼] keys.

- ◆ The range will be set immediately when it is selected.
- Each time the [▲] or [▼] key is pressed, the range switches from one to another in the following order and the maximum value for the selected range is displayed.

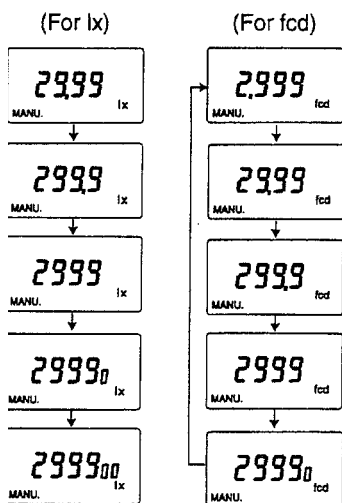

In the above example, the [▲] key is pressed to change the display. The display will change in opposite direction if the [▼] key is pressed.

If the power switch is set to "I" (ON) with the mini plug inserted into the analog output terminal, the "0 to 2.999 lx" range will be selected automatically.

If the mini plug is inserted while measurement is in progress in AUTO range mode, the range used in AUTO range mode will remain effective.

Once a range is selected manually, it will remain unchanged even if the power switch is switched from "O" (OFF) to "I" (ON).

If CCF mode is set, the measuring range that does not cause the color correction factor (CCF) to affect the measured value will be selected in the case of MAN range mode.

Over-range Error

If the measured illuminance exceeds the range during MAN range mode, "-0-" will blink to inform that an over-range error has occurred.

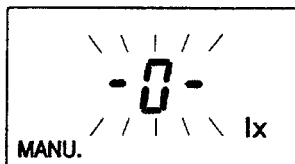

Recording the Measured Illuminance Continuously (Analog Output)

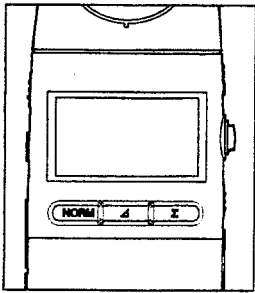

1. Have the instrument ready for operation as described in "Measuring the illuminance" (page 13) and push out the hold button (RUN).

- The range can be switched in RUN state only.

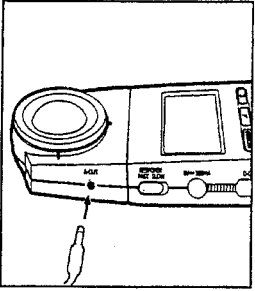

2. Insert the analog output mini plug into the analog output terminal.

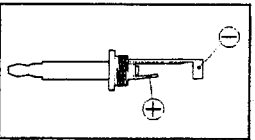

- Connecting the analog output mini plug to a recorder. If you want to record measured illuminance using a recorder, the recorder must be connected to the analog output terminal via the analog output mini plug. The analog output mini plug must be soldered as shown to the cable of the recorder. A shield cable must be used.

3. Select the measuring range suitable for the illuminance to be measured.

- Refer to "Setting the Range Manually" (page 32).

4. Adjust the sensitivity of the recorder according to the illuminance to be measured.

- The analog output level of this instrument is 1mv/div (one display count), and the maximum output voltage 3V (3,000mV).

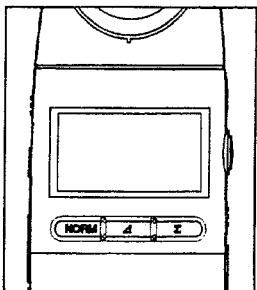

5. Attach the cap to the receptor head (or block the head to prevent entry of external light).

- ◆ "0 lx" will appear in the display section. However, the analog output voltage may not be 0mV due to the offset voltage.

6. Adjust the zero level of the recorder so that the analog output voltage from the instrument equals to the zero level of the recorder.

7. Remove the cap (or block).

- ◆ An analog signal (i.e. voltage) proportional to the measured illuminance will be output, and the measured illuminance will be recorded continuously to the recorder.

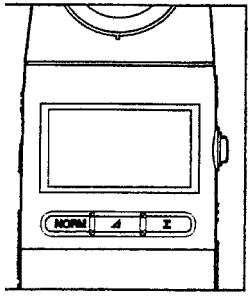

- ▶ A voltage corresponding to the displayed significant digits (0 to 3,000 mV) will be output, irrespective of the currently selected range. The range corresponding to the output voltage is displayed in the display section.
- ▶ In CCF mode, a signal corresponding to the measured value will be output, irrespective of the CCF.
- ▶ The recorder to be connected to the analog output terminal must have an input impedance of $1M\Omega$ or higher. Since the output impedance of this instrument is $10K\Omega$, the indication error will be 1% or less if the input impedance of the recorder is $1M\Omega$ or higher.
- ▶ The measured illuminance is always output from the analog output terminal, irrespective of what is displayed. Thus, it is possible to display the illuminance difference/ratio or integrated illuminance or hold the displayed value even if recording is in progress.
- ▶ To observe the waveform of a flicker light with an oscilloscope, set the response speed selector switch to FAST, and select the range that does not cause the peak value of the flicker light to exceed 3,000 mV.

▶ Measurable range vs analog output for each manual range (with the mini plug inserted into the analog output terminal)

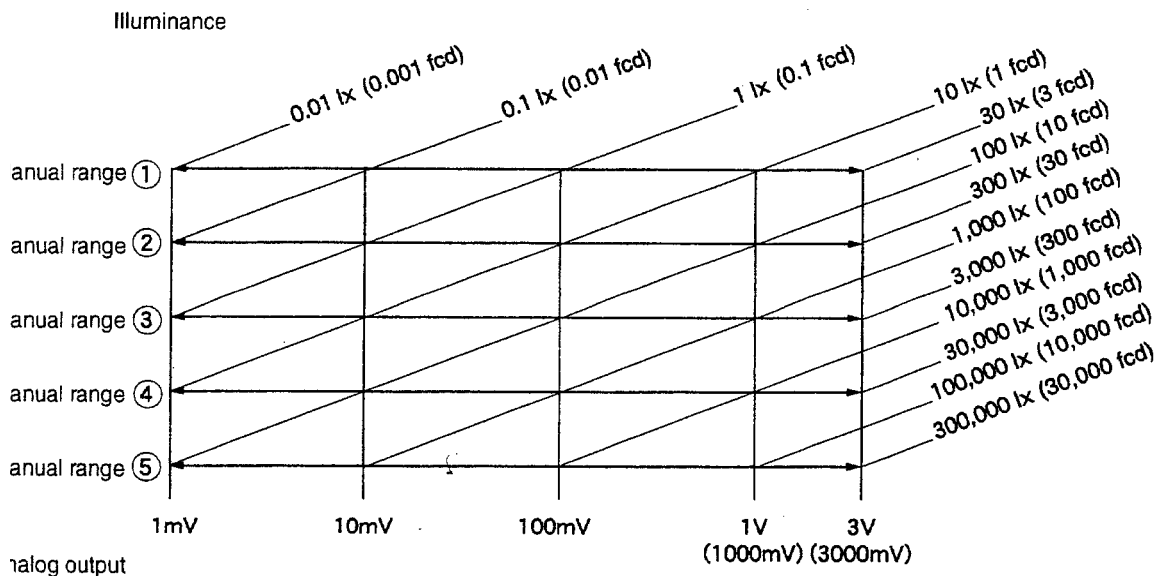

Printing the Measured Data (Digital Output)

Digital Output of the Measured Value

This section explains how to print out the measured data.

To print out the data, the printer cable T-A12 (optional) is required to connect a printer to the instrument.

Printer Requirements

The printer must meet the following requirements.

| | |
|------------------------|----------------------------|
| Number of print digits | : 27 or more |
| Data input | : RS-232C |
| Data control | : Busy |
| Baud rate | : 9,600 |
| Character length | : 7 bits |
| Parity | : Even |
| Stop bit | : 1 bit |
| Basic function | : CR (0DH) carriage return |

Example of recommended printer

Model name: DPU-201GS (Seiko Instruments Inc.)

Procedure

Connect the instrument to the printer with the printer cable T-A12.

- Before connecting them, make sure that the instrument's power switch is set to "O" (OFF)
- Always set the instrument's power switch to "I" (ON) before turning ON the printer's power switch. If the printer's power switch is turned ON first, the printer may not work properly.

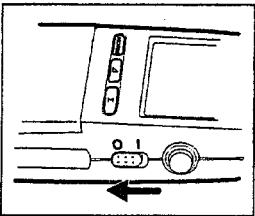

1. Make sure that the instrument's power switch is set to "O" (OFF) and connect the instrument to the printer with the printer cable T-A12.

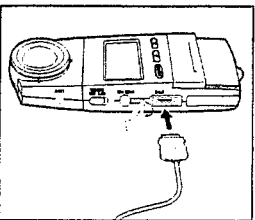

- The illustration on the left shows an example of connecting the instrument to DPU-201GS.

▼ Connection to DPU-201GS

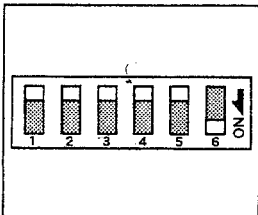
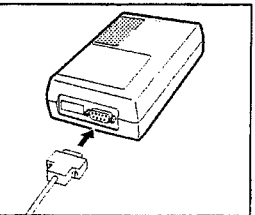

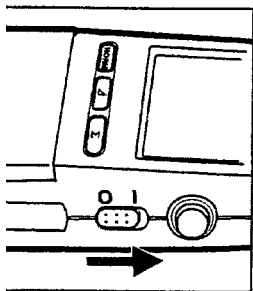

2. Set the instrument's power switch to "I" (ON), then turn ON the printer.

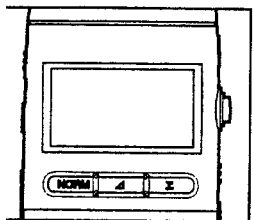

3. Push out the hold button (RUN), and start measurement.

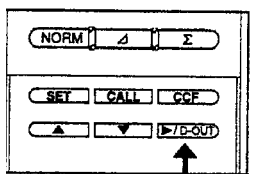

4. Press the **[▶/D-OUT]** key.

- ◆ Each time the key is pressed, the data effective when the key is pressed will be sent to the printer and printed out.
- If you want to hold the data, push in the hold button (HOLD), then press the **[▶/D-OUT]** key.

- ▶ While the printer cable T-A12 is connected to the instrument, consumption current will be approximately 1.5 times as much as when it is disconnected.
- ▶ If you are not going to use the printer, make sure that the printer cable is disconnected.

Print example by DPU-201GS

| | | |
|---------------|---|--|
| 1013 lx | } | NORM: Displays illuminance (lx). |
| 1017 lx | | |
| DLT + 291 lx | } | Δ: Displays illuminance difference (lx). |
| DLT + 306 lx | | |
| DLT - 25.3 lx | | |
| DLT 155.0 % | } | Δ: Displays illuminance ratio (%). |
| DLT 79.6 % | | |
| 0.033 h | } | Σ: Displays integrated illuminance (lx·h). |
| 21.53 lx·h | | |
| 0.037 h | } | Σ: Displays integration time (h). (The print contents are the same as when integrated illuminance is measured.) |
| 24.21 lx·h | | |
| 0.044 h | } | Σ: Displays average illuminance (lx). |
| 26.98 lx·h | | |
| 0.047 h | } | |
| 31.09 lx·h | | |
| 0.049 h | } | |
| 668.9 lx AVG | | |
| 0.050 h | } | |
| 670.1 lx AVG | | |

Connecting to a Personal Computer (Digital Output)

Connecting the instrument to a personal computer with the cable T-A11 allows you to transfer data from the instrument to the computer. The cable must be connected to the digital output terminal provided on the instrument.

Use of the data processing software T-A30 (optional) enables real-time display of measure data and control of multi-point measurement. For a description of how to use the software refer to its instruction manual.

However, it is also possible to transfer measured data to a personal computer without using this data processing software. For a detailed explanation, contact the nearest Minolta-authorized service facility.

- While the cable T-A11 is connected to the instrument, consumption current will be approximately 1.5 times as much as when it is disconnected.
When you have finished measurement with the instrument connected to the personal computer, disconnect the cable T-A11 from the instrument.
- To prevent accidents such as electric shock, read the manual of your personal computer thoroughly and follow the precautions given there.

Separating the Receptor Head from the Main Body

By using the optional adapters T-A20 (for main body) and T-A21 (for receptor head), the receptor head can be separated from the main body for measurement.

Items Required

- Main body adapter
(with an extension cable) : T-A20 (optional)
- Receptor head adapter : T-A21 (optional)

the cable supplied with the adapter is not long enough:

- Use a commercially available 10Base-T network cable (category 5 straight cable). The cable can be extended up to 100 meters.

Measuring Method

If measurement is performed with the receptor head connected to the main body with the extension cable, the measured values and operation of the instrument may be affected if equipment which generates electrical noise is present near the extension cable. In this case, such equipment must be kept away from the cable during measurement.

1. Set the power switch to "O" (OFF).
2. Attach the main body adapter to the instrument.
3. Attach the receptor head adapter to the receptor head (mini receptor head in the case of T-10M).

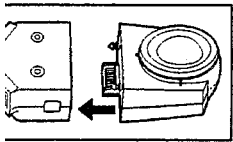
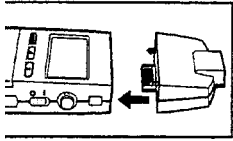

For T-10M

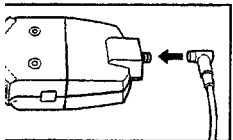
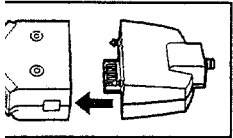

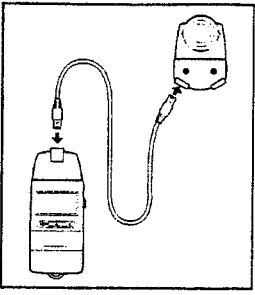

4. Connect both adapters with the extension cable.

5. Set the power switch to "I" (ON) and push out the hold button (RUI)

◆ Measurement will start.

● If the receptor head is connected to the main body through the extension cable and measurement is performed, consumption current will increase by approximately twice.

Fixing the Receptor Head

The receptor head can be fixed in the measuring location (e.g. on a panel) by the following methods. (For the reference measurement plane, refer to page 51.)

- ① By using the tripod fixing screw hole on the back of the receptor head
- ② By using the holes on the receptor head adapter (T-A21)

Dimensions

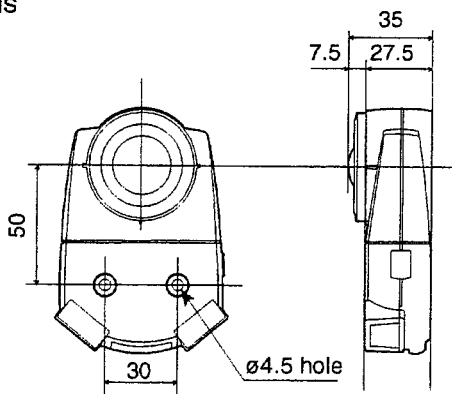

An example of affixing the head to a panel

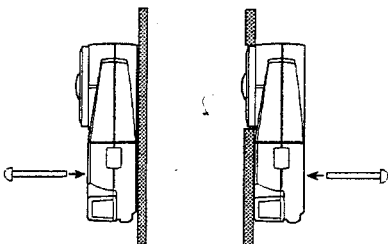

Multi-Point Measurement

This instrument allows you to perform multi-point measurement by using more than two optional receptor heads and adapters. (Up to 30 receptor heads and adapters can be connected.)

Since each receptor head must be powered constantly during multi-point measurement, the optional AC adapter (AC-A10 or AC-A10N) must be used.

Items Required

- › Main body adapter
(with an extension cable) : T-A20 (optional)
- › Receptor head adapter : T-A21 (optional)
- › AC adapter : AC-A10 (optional)

the cable supplied with the adapter is not long enough:

- › Use a commercially available 10Base-T network cable (category 5 straight cable). The cable can be extended up to 50 meters.

Measuring Method

If measurement is performed with the receptor head connected to the main body with the extension cable, the measured values and operation of the instrument may be affected if equipment which generates electrical noise is present near the extension cable. In this case, such equipment must be kept away from the cable during measurement.

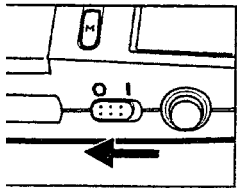

1. Set the power switch to "O" (OFF), and attach the AC adapter to the instrument.

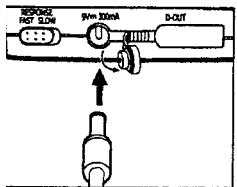

2. Attach the main body adapter to the instrument.

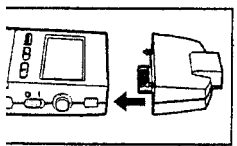

3. Attach a receptor head adapter to each receptor head (mini receptor head in the case of T-10M).

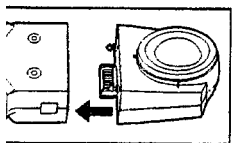

▼ For T-10M

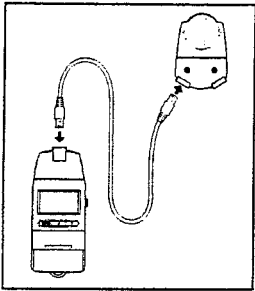
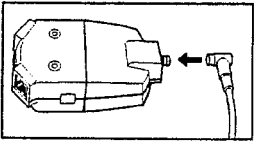
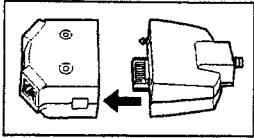

4. Connect both adapters and an extension cable.

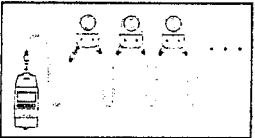

5. Connect the remaining receptor heads serially with extension cables.

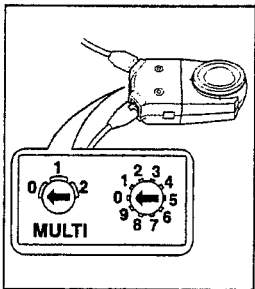

6. Set an ID no. to each receptor head using the rotary switch of the adapters.

- ID nos. can be between 00 and 29.
- Make sure that ID nos. are unique.

- The ID nos. will be read to the main body when the power switch is set to "I" (ON). To set or change them, make sure to set the power switch to "O" (OFF) first. If an ID no. is changed during measurement, it will not be acknowledged by the main body.

Print the ID nos. on labels using a label writer and affix them on the corresponding receptor head adapters. This will help you find the ID nos. easily.

▼ An example of affixing a label "09" (ID no.) on the corresponding receptor head adapter

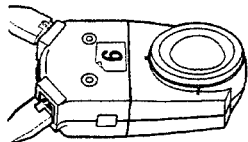



7. Set the power switch to "I" (ON).

- ◆ The smallest ID no. among those currently set will be displayed at the upper right of the display section.
- Press the [▲] and [▼] keys to check that the ID no. switches from one to another. Make sure that the ID nos. of all the connected receptor heads are displayed one at a time (they are displayed in the ascending order: starting from the smallest ID no.).
- If they are not displayed, check connection between the main body and receptor heads as well as the ID nos.

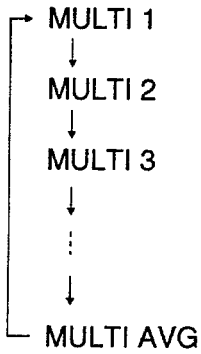

Average value of those measured by all the connected receptor heads

In the above example, the [▲] key is pressed to change the display. The display will change in opposite direction if the [▼] key is pressed.

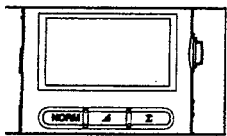

8. Push out the hold button (RUN).

- ◆ Measurement will start, and the value measured by one of the receptor heads or the average value of those measured by the connected receptor heads will be displayed.
- Measured values are displayed in the order of ID nos.
- Each time the [▲] or [▼] key is pressed, the measured value will switch from one receptor head to another.

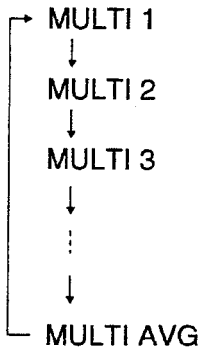

Average value of those measured by all the connected receptor heads

In the above example, the [▲] key is pressed to change the display. The display will change in opposite direction if the [▼] key is pressed.

If a large number of receptor heads are connected, the display will not switch from MULTI AVG immediately even if the [▲] (or [▼]) key is pressed. In this case, keep holding down the [▲] (or [▼]) key.

Notes on Multi-Point Measurement

Receptor Head ID No.

- When setting receptor head ID nos., make sure that they are unique. If not, incorrect measurement results will be obtained.

Illuminance Difference/Ratio Measurement

- The reference value must be set for each receptor head.
- Measured value will be displayed individually for each receptor head.

Integrated Illuminance Measurement

- Illuminance measurement setting must be made for each receptor head.
- Measured value will be displayed individually for each receptor head.

Automatic Integration Stop Function

- Integration time/integrated illuminance must be set for each receptor head.
- When integration is paused, the unit (lx·h, lx, h) will blink individually for each receptor head.

Color Correction Factor (C.C.F)

- The color correction factor must be set for each receptor head, and whether or not to operate the instrument in CCF mode (i.e. whether or not to apply the factor) must also be set for the receptor head.
- In CCF mode, the value which has been corrected by the CCF will always be displayed irrespective of measurement mode (illuminance difference/ratio, integrated illuminance, automatic integration stop and MULTI AVG display).

Manual Range Setting

Before setting the measuring range for multi-point measurement, the mini plug must be connected to the analog output terminal of the receptor head. The following points differ from when only one receptor head is connected.

- The range which was in effect when the mini plug was connected will be selected.
- It is not possible to change the range since the [▲] and [▼] keys are used to switch the receptor head from one to another.
- If you want to change the range, insert the mini plug while measurement is performed with the desired range. (For the auto/manual measuring range, refer to page 32.)

MULTI AVG Display

- If an error (range-over error, communication error etc.) occurs with any of the connected receptor heads, no data will be displayed during measurement.
- No measured values will be displayed in illuminance difference/ratio, integrated illuminance and automatic integration stop modes.
- The CCF mark will not be displayed even if the color correction factor (CCF) is valid.

Introduction of Accessories

Standard Accessories

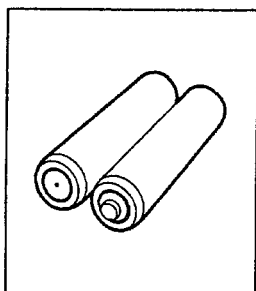

Batteries

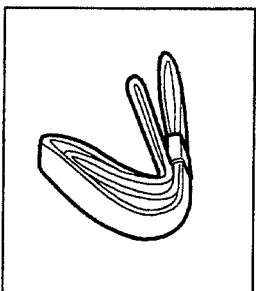

Strap

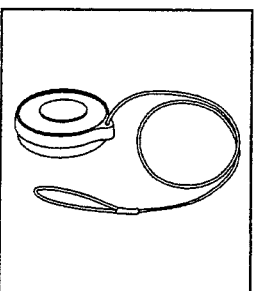

Cap (for T-10 only)

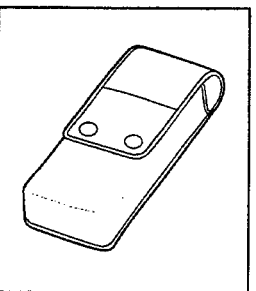

Case T-A10

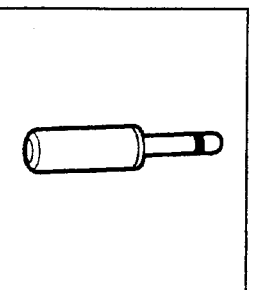

Mini plug for analog output

Optional Accessories

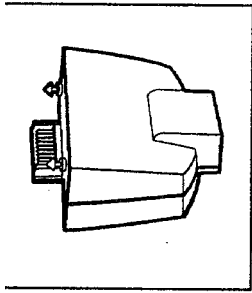

**Main body adapter
T-A20**

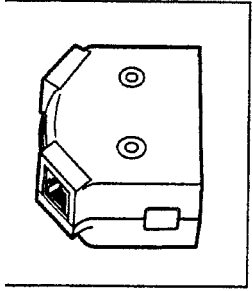

**Receptor head
adapter
T-A21**

- With an extension cable (1m)

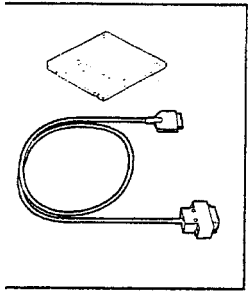

**Data processing
software
T-A30**

- With a connecting cable (T-A11)

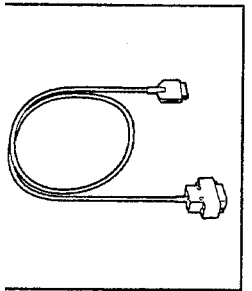

**Connecting cable
T-A11 (for personal
computer)
T-A12 (for printer)**

**AC adapter
(AC-A10 worldwide
except N.America
; AC-A10N in
N.America)**

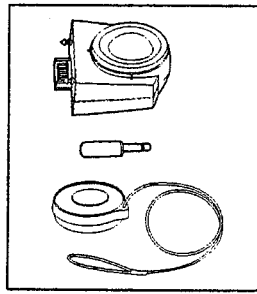

T-10 receptor head

- With a mini plug for analog output

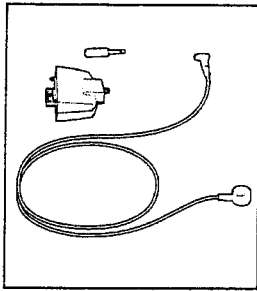

**T-10M receptor
head (mini type)**

- With a mini plug for analog output

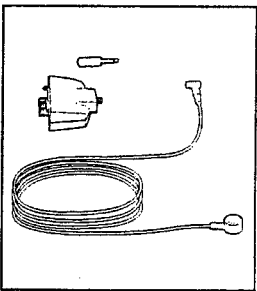

**T-10Ms receptor
head (water-proof
mini type: 5m)**

- With a mini plug for analog output
- * Custom order

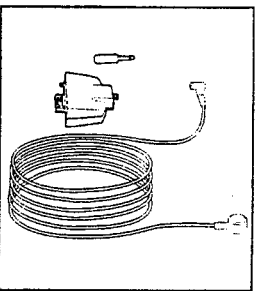

**T-10ML receptor
head (water-proof
mini type: 10m)**

- With a mini plug for analog output
- * Custom order

System Diagram

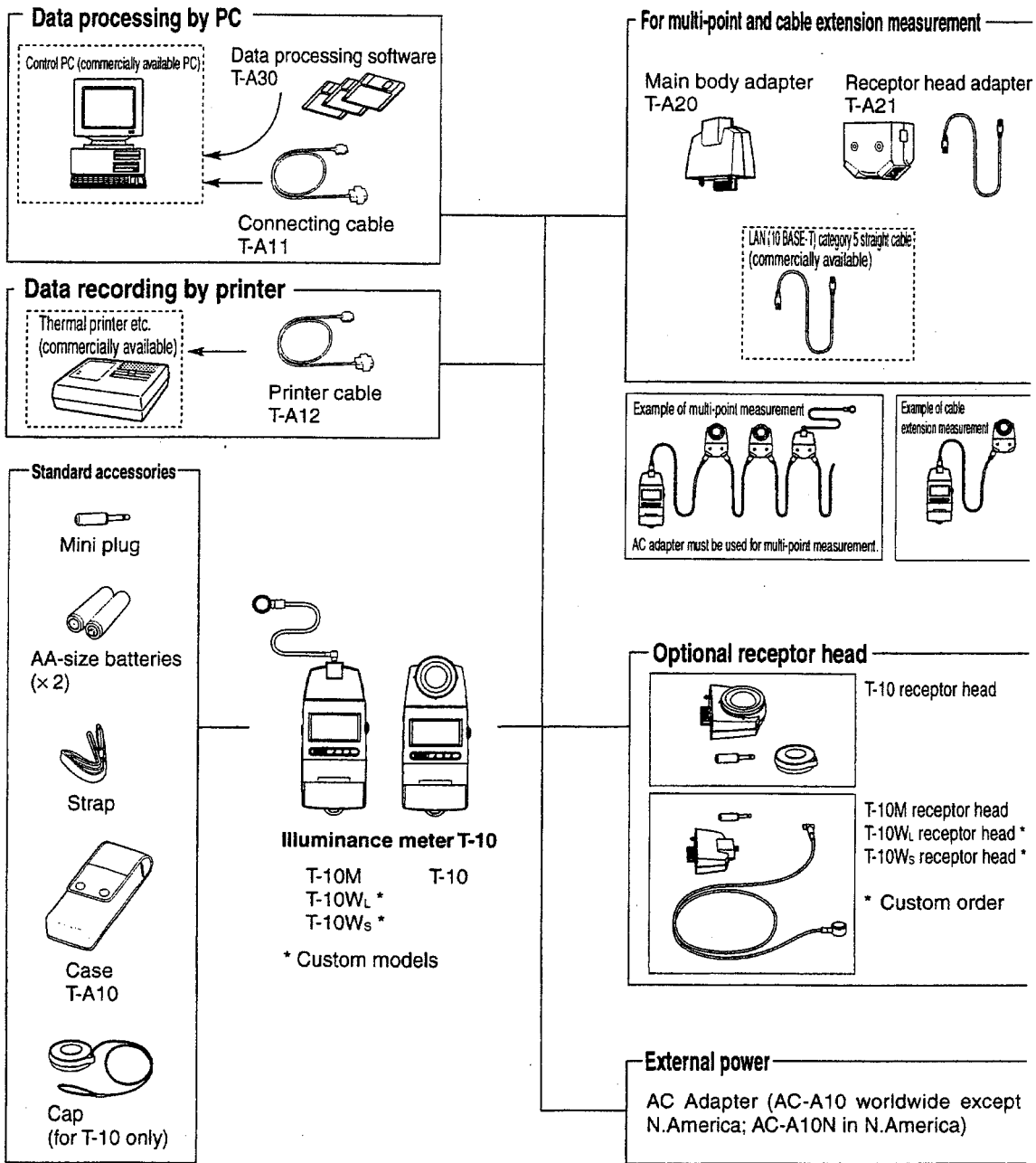

Explanation

Error Messages

An error may occur during operation due to some problems. If an error occurs, refer to the table below and take the necessary action.

| Message | Description | Action |
|--------------|---|--|
| ErrU ErrE | Initial communication error No response from the receptor head during initial communication | Check connection. If the instrument is connected properly, contact the nearest Minolta-authorized service facility. |
| | Start command error The receptor head has not received the start command, because, for instance, the receptor head was not connected to the main body at the time the power was turned ON. | Set the power switch to "I" (ON) again. If this message reappears, contact the nearest Minolta-authorized service facility. |
| Err | EEPROM error Error with the EEPROM data (in the receptor head) | Remove the batteries (or AC adapter), then re-install them. If this message reappears contact the nearest Minolta-authorized service facility. |
| ErrA | Preset value error The value is outside the settable range. | Check the settable range, and make sure that the value is inside the range. |
| ErrC | Communication error (main body ↔ receptor head) Communication between the main body and receptor head was not performed properly. | Check connection. If the instrument is connected properly, contact the nearest Minolta-authorized service facility. |

Reference Measurement Plane / Dimension Diagram

(Unit: mm)

The top of the receptor window is used as the reference plane for measurement as shown below.

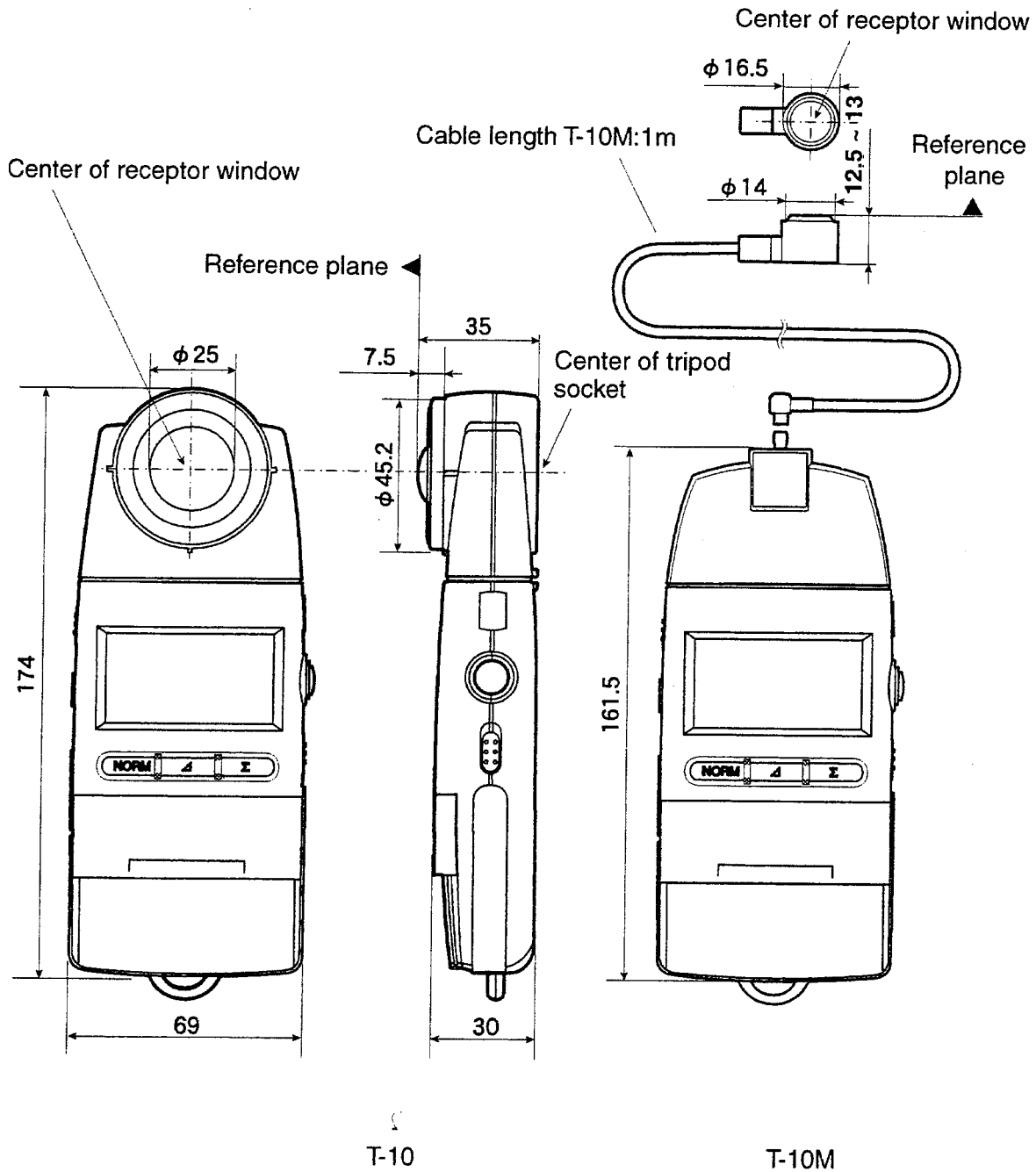

Relative Spectral Response

Ideally, the relative spectral responsivity of the illuminance meter should match $V(\lambda)$ the spectral luminous efficiency of the human eye for photopic vision.

As shown in the graph above, the relative spectral responsivity of Minolta Illuminance Meters T-10 is within 8% (f_1) of the CIE spectral luminous efficiency $V(\lambda)$.

CIE ; Commission Internationale de l'Eclairage

f_1 (CIE's symbol) ; The degree to which the relative spectral responsivity matches $V(\lambda)$ is characterized by means of the error f_1 .

$$f_1 = \frac{\int_{\lambda=380}^{780} |S^*(\lambda)_{rel} - V(\lambda)| d\lambda}{\int_{\lambda=380}^{780} v(\lambda) d\lambda} \cdot 100\%$$

Note : The constant has the dimension nm^{-1}

$S^*(\lambda)_{rel}$ normalized relative spectral responsivity

$$S^*(\lambda)_{rel} = \frac{\int_{\lambda=380}^{780} S^*(\lambda)_A V(\lambda) d\lambda}{\int_{\lambda=380}^{780} S^*(\lambda)_A S(\lambda)_{rel} d\lambda} S(\lambda)_{rel}$$

$S(\lambda)_A$ Spectral distribution of the illuminant used in the calibration (standard illuminant A)

$S(\lambda)_{rel}$ Relative spectral responsivity with arbitrary reference

$V(\lambda)$ Spectral luminous efficiency of the human eye for photopic vision

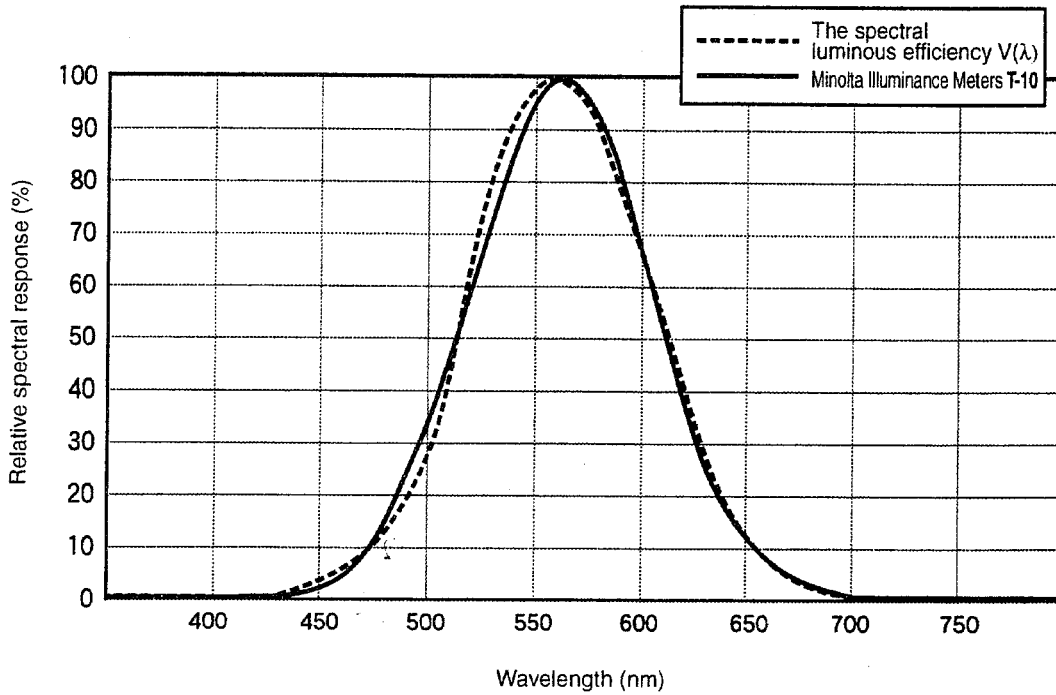

Cosine Correction Characteristics

Since the brightness at the measurement plane is proportional to the cosine of the angle at which the light is incident, the response of the receptor must also be proportional to the cosine of the incidence angle.

The graph above shows the cosine correction characteristics of Minolta Illuminance Meters T-10.

The cosine error of T-10 are shown in the table right.

| Incidence angle (deg.) | Cosine error (within) |
|------------------------|-----------------------|
| 10° | ± 1% |
| 30° | ± 2% |
| 50° | ± 6% |
| 60° | ± 7% |
| 80° | ± 25% |

